



Ferramenta per ante a scomparsa girevoli in legno fino a 35 kg. Allestimento del frontale uniforme e complanare con schema delle fughe omogeneo. Versione Pull con maniglia e sistema ammortizzatore integrato.

Highlight di prodotto

-  **Produttività** Montaggio semplice grazie all'elevato grado di preassemblaggio con regolazione intuitiva
-  **Comfort** Supporto per il movimento ergonomico per una sequenza di movimenti uniforme e leggera
-  **Estetica** Consente costruzioni con e senza maniglia – la tecnologia resta invisibile

Requisiti tecnici

-  10–35 kg
-  1900–2700 mm
-  440–750 mm
-  18–26 mm

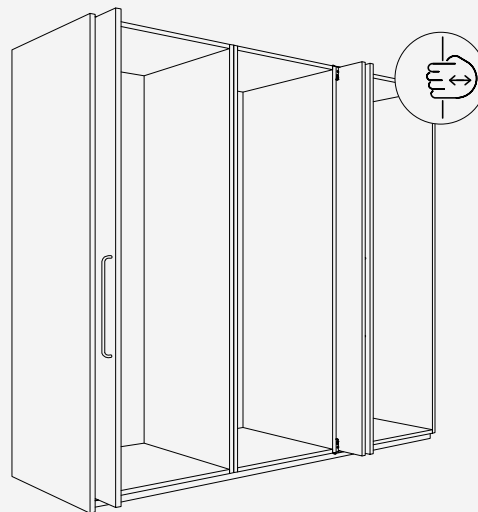

Esempi di montaggio

Ante a battuta su fondo e coperchio

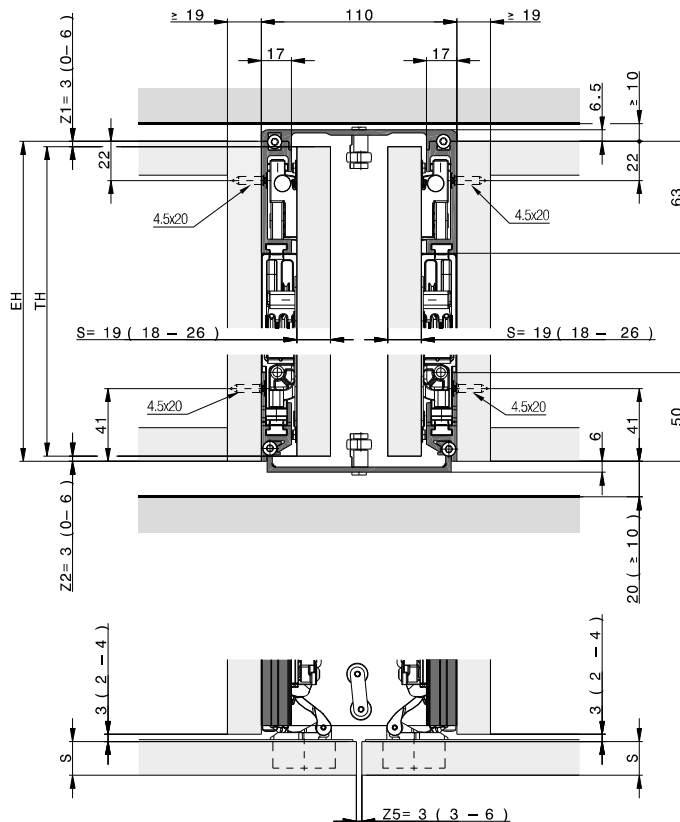
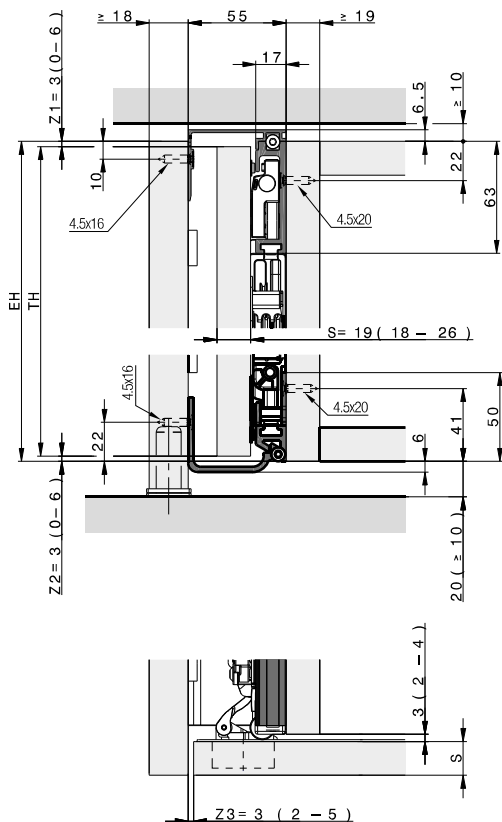

Componenti necessari per un'armadio

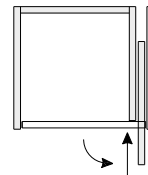
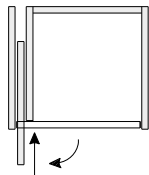

Hawa Concepta III 35 Pull, sinistra

	N°.
Hawa Concepta III 35, guarnitura di base sinistra, altezza porta 1900–2700 mm	30996
Hawa Concepta III 25/35, guarnitura a scomparsa Pull, sinistra	31000
Profilo longherone L= 2474 mm, per altezza porta 1900–2700 mm, alluminio, anodizzato	30771

Hawa Concepta III 35 Pull, destra

	N°.
Hawa Concepta III 35, guarnitura di base destra, altezza porta 1900–2700 mm	30997
Hawa Concepta III 25/35, guarnitura a scomparsa Pull, destra	31001
Profilo longherone L= 2474 mm, per altezza porta 1900–2700 mm, alluminio, anodizzato	30771

Calcoli dei rapporti di peso e dimensionali dell'anta

Il peso massimo è conseguenza della grandezza dell'anta.

		DE Türbreite / FR Largeur de porte / EN Door width / IT Larghezza anta / ES Ancho de puerta						
		440	500	550	600	650	700	750
DE Türhöhe / FR Hauteur de porte / EN Door height / IT Altezza anta / ES Altura de puerta	2700	35	35	35	35	35	35	35
	2650	35	35	35	35	35	35	35
	2600	35	35	35	35	35	35	35
	2550	35	35	35	35	35	35	35
	2500	35	35	35	35	35	35	35
	2450	35	35	35	35	35	35	34
	2400	35	35	35	35	35	35	33
	2350	35	35	35	35	35	34	32
	2300	35	35	35	35	35	34	31
	2250	35	35	35	35	35	33	31
	2200	35	35	35	35	34	32	30
	2150	35	35	35	35	33	31	29
	2100	35	35	35	35	32	30	28
	2050	35	35	35	34	31	29	27
	2000	35	35	35	33	30	28	26
	1950	35	35	35	32	29	27	26
1900	35	35	34	31	29	27	25	

DE Maximale Gewichte in kg / FR Poids maximale en kg / EN Maximum weights in kg / IT Pesi massimo in kg / ES Pesos máximos en kg

		DE Türgewicht in kg / FR Poids de porte en kg / EN Door weight in kg / IT Peso anta in kg / ES Peso de puerta en kg						
--	--	---	--	--	--	--	--	--

Hawa Configuratore











www.hawa.com/configuratore →

Lista degli elementi singoli che sono compresi nelle guarniture

Guarnitura di base per 1 anta a scomparsa girevole fino a 35 kg

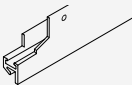
	N°.
Hawa Concepta III 35, guarnitura di base sinistra, altezza porta 1900–2700 mm	30996
Hawa Concepta III 35, guarnitura di base destra, altezza porta 1900–2700 mm	30997



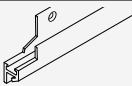
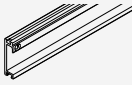



Guarnitura formata da:

		30996	30997	N°.
	Dadi di congiunzione per fissaggio delle cerniere, plastica, nera	4	4	30686
	Base di montaggio per cerniera con regolazione in altezza, acciaio, nichelato	1	1	30738
	Cerniera, ammortizzatore e molla di chiusura, acciaio, nichelato	4	4	31070
	Set per cerniera, 8 viti 4x16 mm, 3 paracolpi per ante	1	1	30811
	Profilo per guida magnetica con nastro biadesivo, acciaio, nero, L = 730 mm	2	2	30983
	Viti Euro, 6x13 mm, acciaio, nere, set da 6 pezzi	1	1	30986
	Binario di guida inferiore sinistro, alluminio, anodizzato, L = 838 mm	1		30805
	Binario di scorrimento superiore sinistro, alluminio, anodizzato, L = 838 mm	1		31059
	Viti a testa svasata, 4,5x20 mm, acciaio, zincate, set da 16 pezzi	1	1	30810
	Set di utensili per regolazione	1	1	31047
	Binario di guida inferiore destro, alluminio, anodizzato, L = 838 mm		1	30806
	Binario di scorrimento superiore destro, alluminio, anodizzato, L = 838 mm		1	31060

Guarnitura a scomparsa adeguata

	N°.
Hawa Concepta III 25/35, guarnitura a scomparsa Pull, sinistra	31000
Hawa Concepta III 25/35, guarnitura a scomparsa Pull, destra	31001

Guarnitura formata da:

		31000	31001	N°.
	Unità di inserimento Hawa Concepta III 25/35 Pull, sinistra	1		31040
	Angolare di fermo terminale Pull, acciaio zincato	1	1	31414
	Ammortizzatore con fermo terminale	1	1	31221
	Set di coperture Hawa Concepta III Pull, per battute sinistre, plastica, nera	1		30964
	Unità di inserimento Hawa Concepta III 25/35 Pull, destra		1	31041
	Set di coperture Hawa Concepta III Pull, per battute destre, plastica, nera		1	30965

Parti di collegamento del mobile

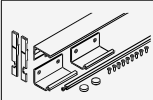
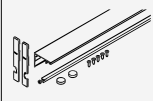
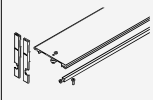
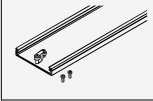
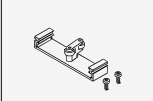
		mm	N°.
	Set di Connector 55 mm, per collegamento del lato esterno con il mobile	560	31005
	Connector superiore 55 mm, per collegamento del lato esterno con il mobile	560	31430
	Connector superiore 110 mm, per due porte a scomparsa girevoli	500	31006
	Connector inferiore 110 mm, per due porte a scomparsa girevoli	500	31246
	Connector inferiore 110 mm, per due porte a scomparsa girevoli (per montaggio davanti a uno zoccolo fisso)	26	31007

Guide

		N°.
	Guida per due porte scorrevoli a battente ad azione singola, alluminio	25680

Accessori

		N°.
	Supporto per dispositivo di spegnimento automatico Halemeier Tasto adatto articolo 36 979 01 per dispositivo di spegnimento automatico Halemeier (Safety Box)	31020

Guarnitura raddrizza-ante

→ **Dettagli alla voce accessori a partire da pagina 323**

Alluminio, grezzo

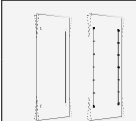
		Nr.
	Ferramenta di allineamento per porte 2040–2600 mm, alluminio	056.3192.072
	Ferramenta di allineamento per porte 1715–2275 mm, alluminio	056.3192.079

Alluminio, anodizzato

		N°.
	Ferramenta di allineamento per porte 2240–2850 mm, alluminio, anodizzato	056.3192.071
	Ferramenta di allineamento per porte 2040–2600 mm, alluminio, anodizzato	056.3192.082
	Ferramenta di allineamento per porte 1715–2275 mm, alluminio, anodizzato, accorciabile per porte 1215–1715 mm	056.3192.080

Alluminio, nero anodizzato

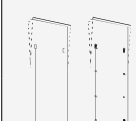
		N°.
	Ferramenta di allineamento per porte 2240–2850 mm, alluminio, nero anodizzato	056.3192.074
	Ferramenta di allineamento per porte 2040–2600 mm, alluminio, nero anodizzato	056.3192.075
	Ferramenta di allineamento per porte 1715–2275 mm, alluminio, nero anodizzato	056.3192.081

Guarnitura raddrizza-ante

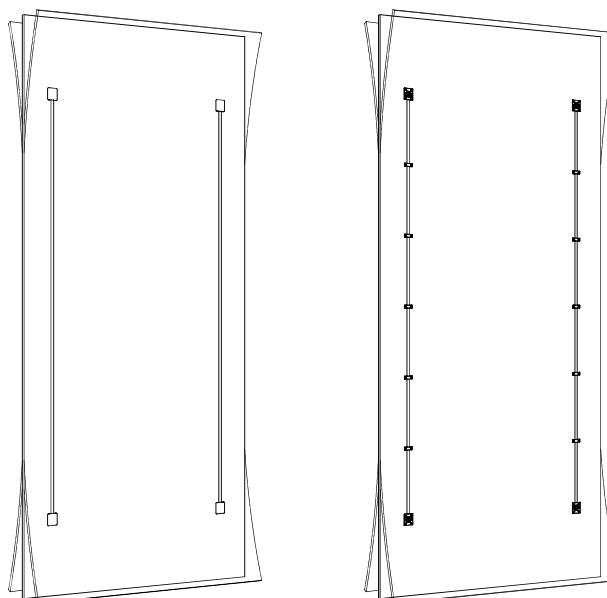

Ulteriori esempi di montaggio
Armadio sovrapposto

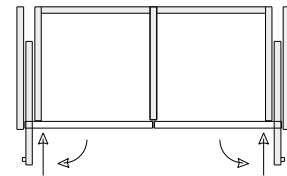
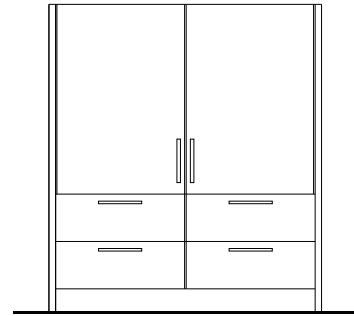
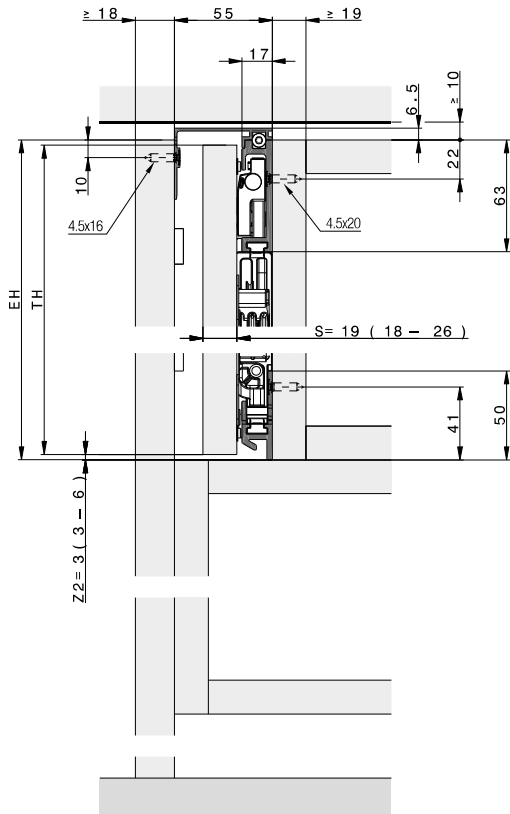

Armadio senza fondo del mobile

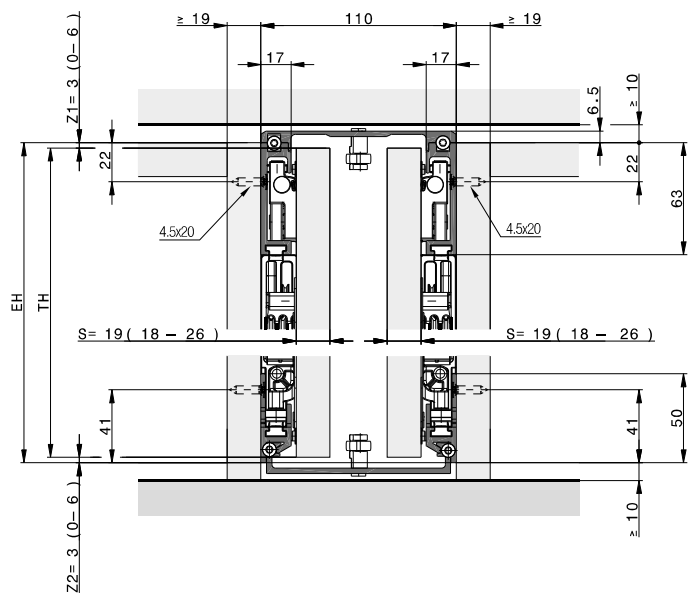
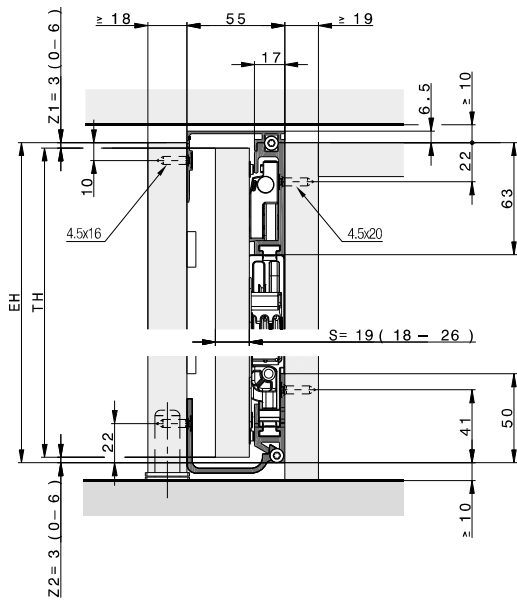

Ante all'interno

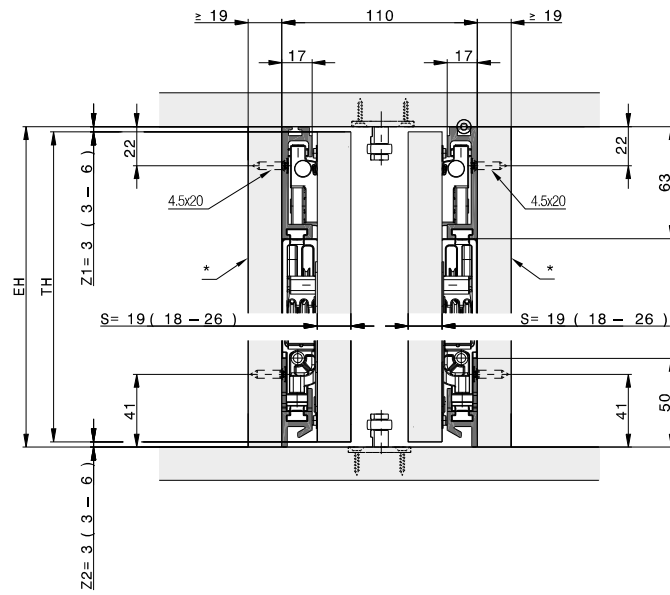
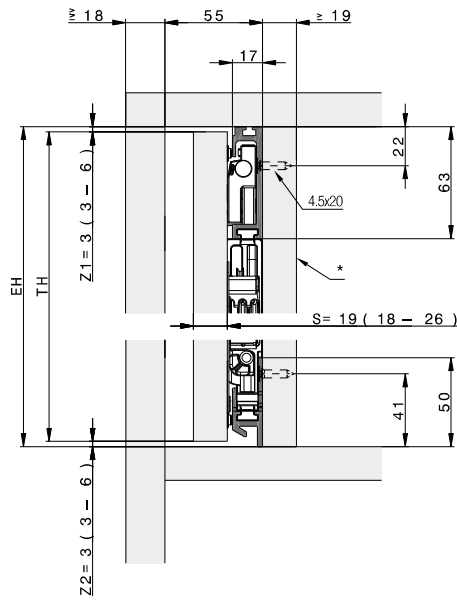

* smontabile

Ante ad altezza soffitto

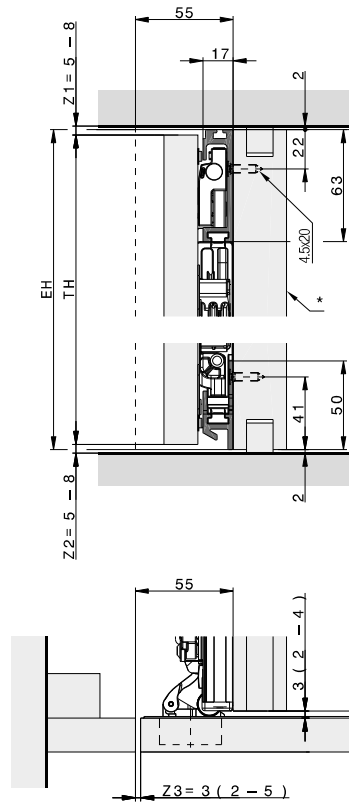

* smontabile

Calcolo profondità ferramenta

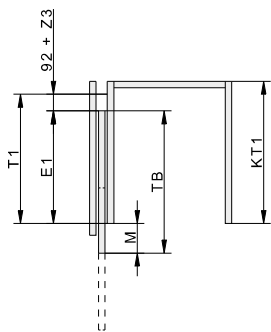

	mm
T1	≥ 414

	mm
T1	$TB + 92 + Z3 - M$
E1	$TB - M$
M	$\geq S + 3$ $\leq TB - 320$

Anta a filo del lato esterno

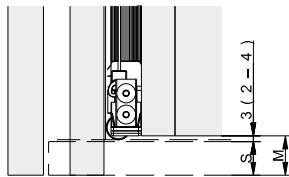

Anta sporgente

